

128G双面铜版纸，骑马钉印刷，英文在前，  
中文在后，单页尺寸105\*148.5mm  
料号：2.11.036

# TPU Tail Bag User Manual

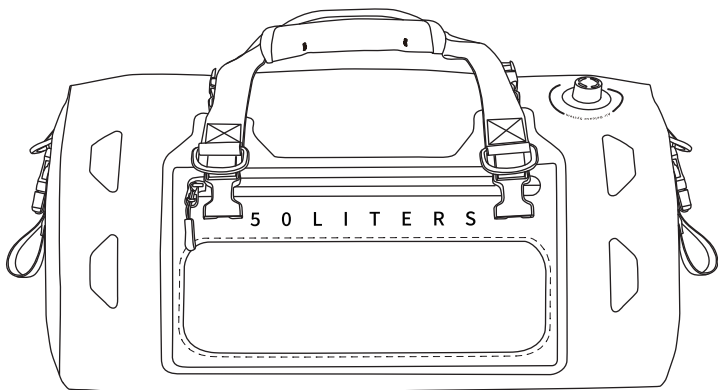





\*Please read this manual carefully before using this product to avoid improper use causing product damage.



Scan QR Code To Watch  
The Installation Video

## Accessories List

Serial Number	Name	Diagram	Quantity	Remarks
①	TPU Tail Bag		1 pc	
②	Shoulder Strap		1 pc	
③	LOBOO Quick Release Strap		2 pcs	
④	Information Card		1 pc	

## Product Illustration

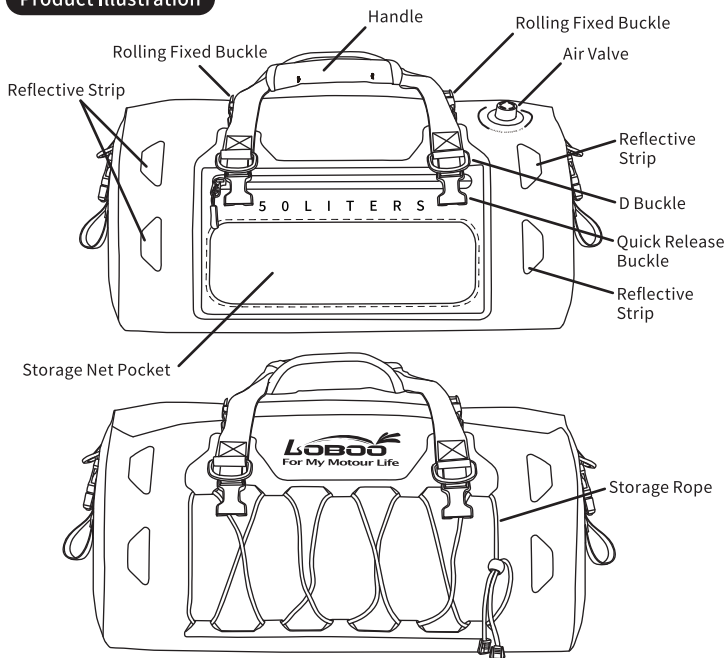

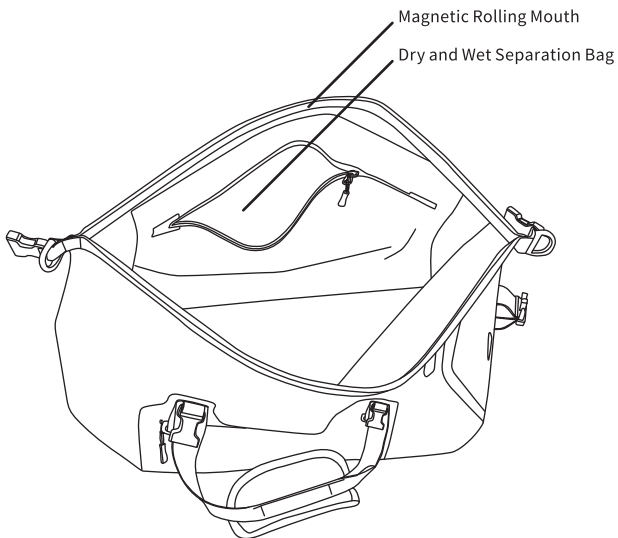
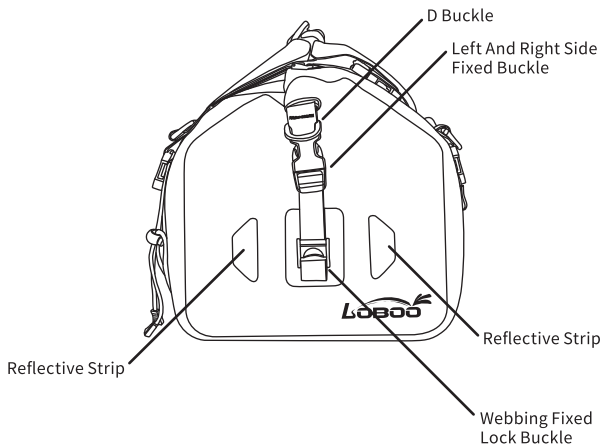

## Tail Bag

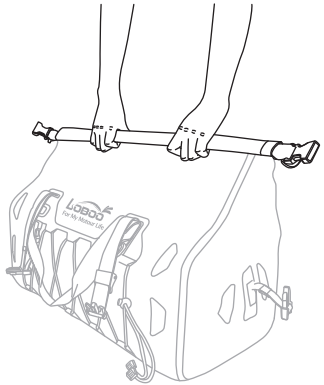
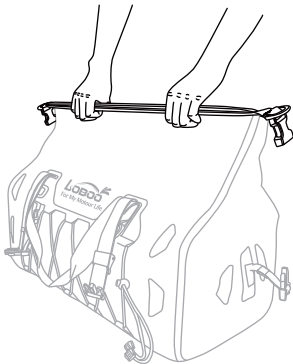

1. Close the magnetic rolling mouth, and fold it down three times according to the width of the magnetic strip (IPX6 level waterproof performance).

2. During the folding process, if the bag is inflated, you can unscrew the air valve, and after folding three times, tighten the air valve.

Air Valve



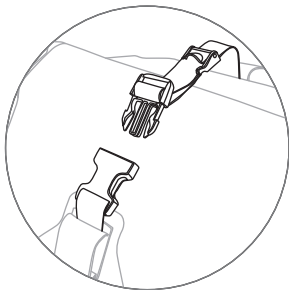
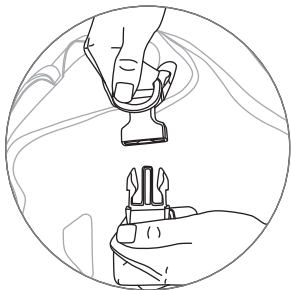

3. The buckles on both ends of the rolling mouth are connected to the fixed buckles on the left and right sides of the bag body, and adjust the length of the webbing to tighten the webbing fixed lock buckle.

4. Rolling mouth fixed buckle: the rear middle buckle is connected with the front middle fixed buckle, and adjust the length of the webbing to tighten the webbing fixed lock buckle.



5. Put the hand-held webbing into the hand-held pad on the other side, and stick the Velcro.

6. Operation completed.

## Shoulder Strap

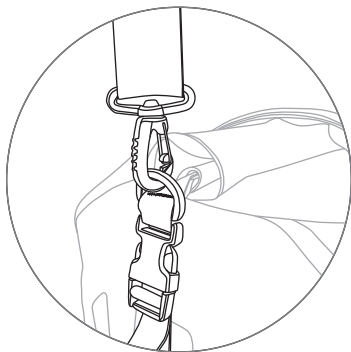
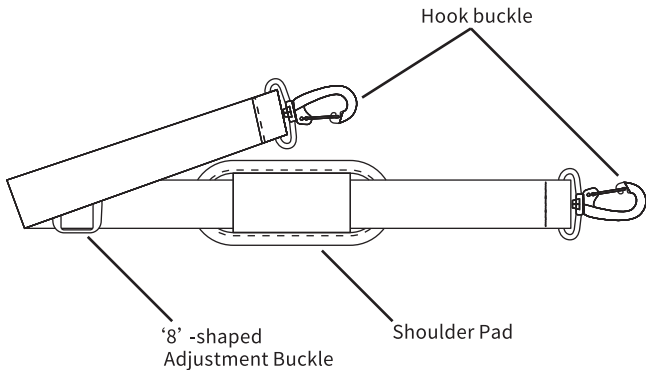

Shoulder carry:  
Connect the hook buckle of the  
shoulder strap to the D buckle  
on the side of the bag body

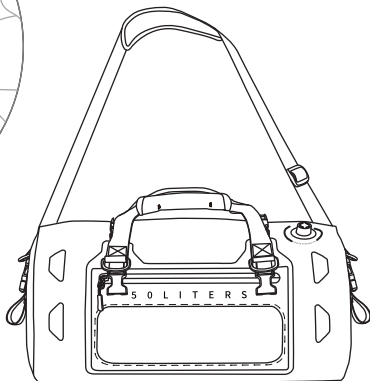

## Fixation Method

### LOBOO Quick Release Strap x 2

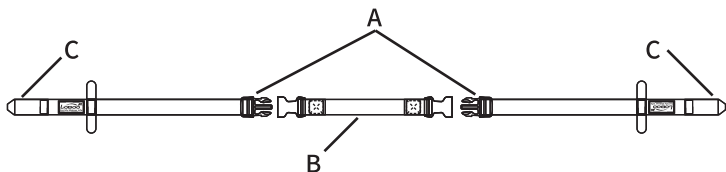

### Fixation Method One (LOBOO Quick Release Strap Fixation)

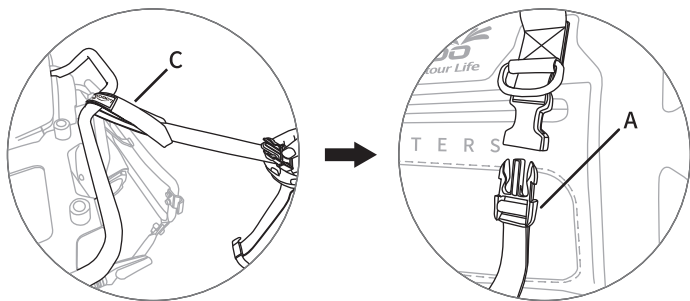

1. On both sides of the motorcycle top case rack, use C to tie 4 fixed points respectively, as shown in the figure.

2. Connect LOBOO Quick Release Strap A with the quick release buckle of the bag body.



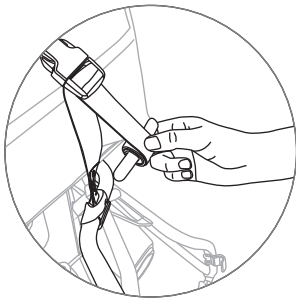

3. After tightening, adjust the length of the webbing storage strap and stick the Velcro.

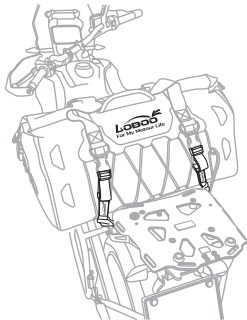

4. Operation completed.

## Fixation Method Two (LOBOO Quick Release Strap Fixation)

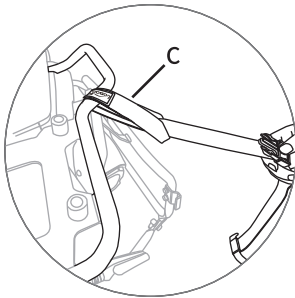

1. On both sides of the motorcycle top case rack, use C to tie 4 fixed points respectively, as shown in the figure.

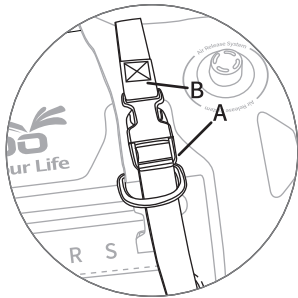

2. Connect LOBOO Quick Release Strap A and B, pass through the double D buckle and directly tie the tail bag.

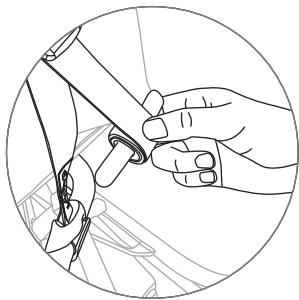

3. After tightening, adjust the length of the webbing storage strap and stick the Velcro.

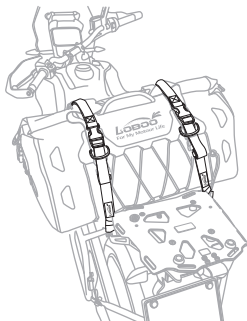

4. Operation completed.

## Precautions For Use

1. After each use, wipe off the stains on the surface of the tail bag with a soft damp cloth and soap (do not use bleach, fabric softener or other acidic and alkaline cleaners), do not machine wash, comform ironing, dry cleaning and any form of drying, let it dry naturally, do not expose it to the sun for a long time.
2. When not in use for a long time, the tail bag should be placed in a dry and cool environment to avoid mildew causing damage to the tail bag; and regularly clean the dust and dirt on the surface of the tail bag to extend its service life.
3. Before going out, check the handle, shoulder strap and quick release strap of the tail bag to avoid aging affecting normal use. When using in harsh outdoor environments, do not use insect repellent on the surface of the tail bag. Please avoid sharp objects scratching the tail bag fabric during use to avoid affecting the waterproof performance.

# Warranty Card



Please read this after-sales service guarantee card carefully. If you cannot accept it, please contact the dealer for return and exchange in time. Installation and use means acceptance of this after-sales service term.

## After-sales Service Terms

1. One-year free warranty period, this product can enjoy free repair service within one year from the date of sale if there are quality problems under normal circumstances.
2. Limited warranty: After the one-year warranty period expires, LOBOO will provide paid warranty service, the cost is based on the actual replacement material cost, and no labor cost is charged separately.

## Free warranty service does not include the following

1. No warranty card or cannot provide valid purchase proof.
2. Improper installation, use, man-made or accidental damage, self-disassembly, self-modification and repair, etc.

## Return and Exchange Information

Platform ID: \_\_\_\_\_ Order Number: \_\_\_\_\_

Contact Name: \_\_\_\_\_ Contact Phone: \_\_\_\_\_

Return Address: \_\_\_\_\_

## Description

Please keep this card properly and send it back with the product (copy is valid)



# 摩托车旅行防水包 (TPU款) 说明书

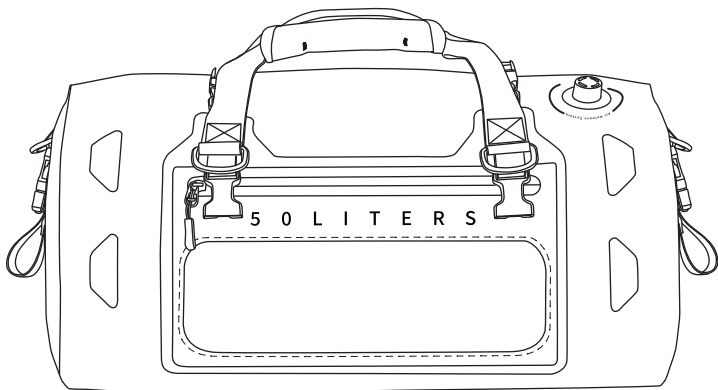





\*使用本产品前请仔细阅读本说明书，  
以免使用不当造成产品损坏。



扫码观看安装  
使用教程视频

## 配件清单

序号	名称	图例	数量	备注
①	摩托车旅行防水包(TPU款)		1个	
②	肩带		1条	
③	LOBOO快拆绑带		2条	
④	信息卡		1张	

## 产品图示

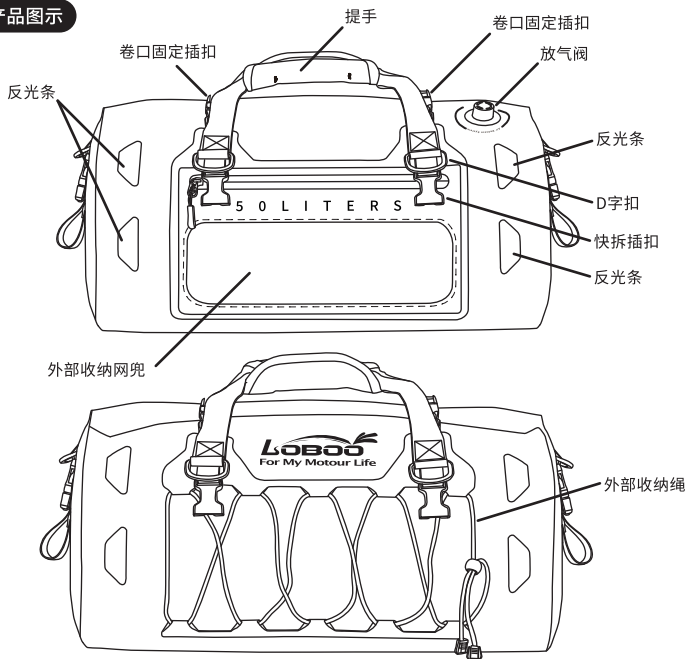

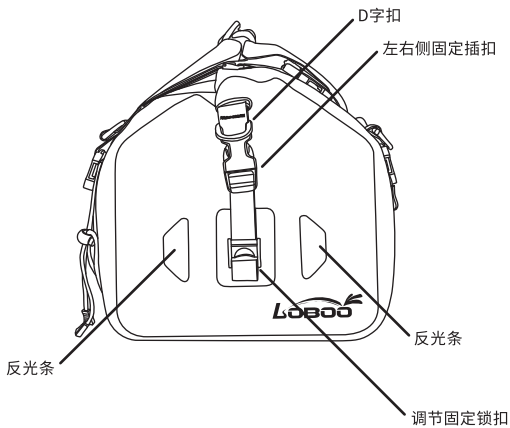



## 防水包使用说明

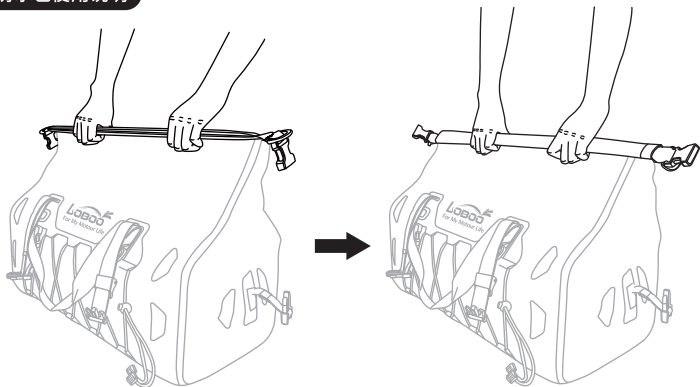

1. 闭合磁吸卷口, 并按磁条宽度  
往下卷折三次 (IPX6级防水性能)。

2. 卷折过程中, 如包内胀气,  
可拧开放气阀, 并完成卷  
折三次后, 拧紧放气阀。

放气阀

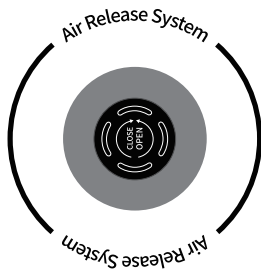

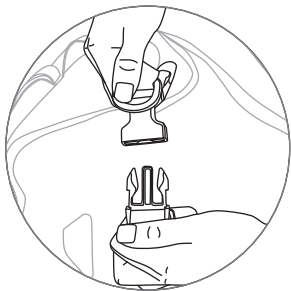

3. 卷口两头插扣分别与包身左侧、右侧固定插扣连接,并调整织带长度紧固调节固定锁扣。

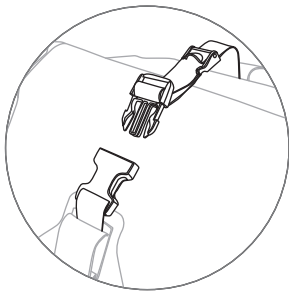

4. 卷口固定插扣:后插扣与前中固定插扣连接,并调整织带长度紧固调节固定锁扣。



5. 将手提织带包入另一边的手提垫,并粘合魔术贴。



6. 操作完成。

## 肩带使用说明

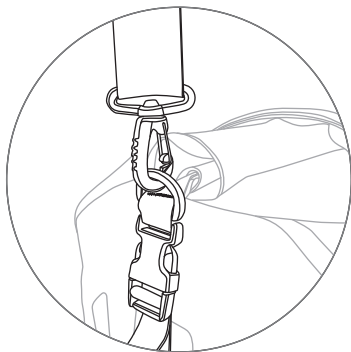
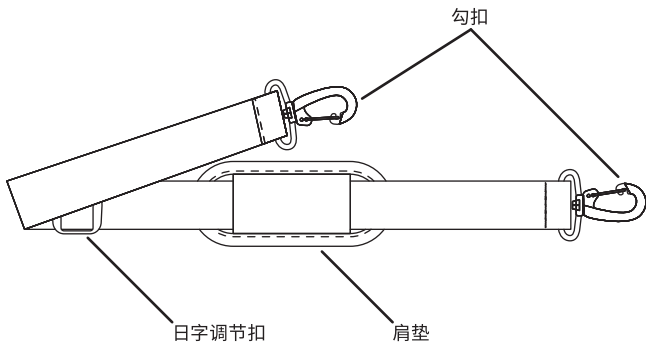

单肩背负：肩带勾扣与包身侧面的D字扣连接



## 固定方式使用说明

### LOBOO快拆绑带 x 2条

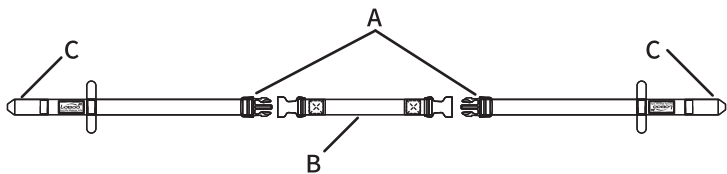

### 固定方式一(LOBOO快拆绑带固定)

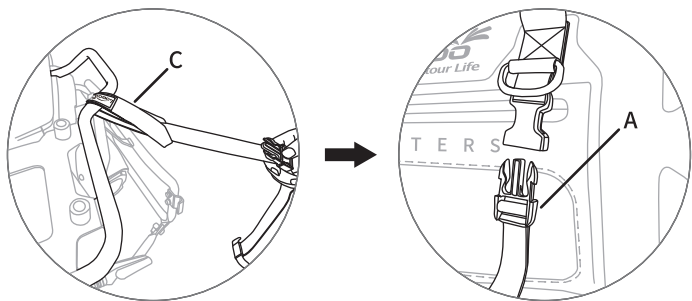

1. 在摩托车尾架两边,用C  
分别绑4个固定点,如图。

2. LOBOO快拆绑带A与  
包身快拆插扣连接。

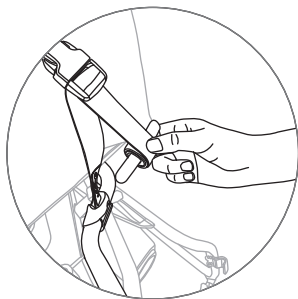

3. 绑紧后,调整织带收纳带长度并粘合魔术贴。

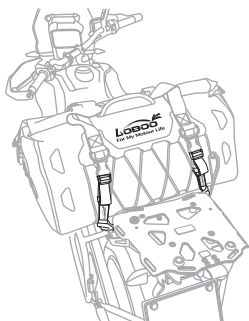

4. 操作完成。

## 固定方式二(LOBOO快拆绑带固定)

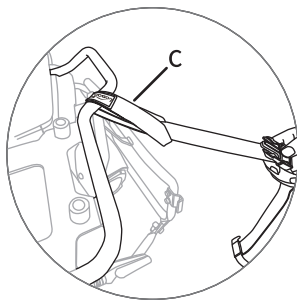

1. 在摩托车尾架两边,用C分别绑4个固定点,如图。

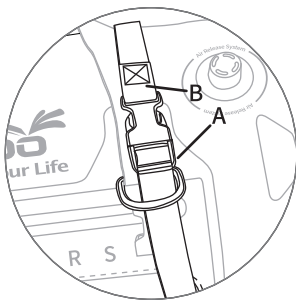

2. 将LOBOO快拆绑带A和B连接起来,穿过D字扣直接捆绑防水包。

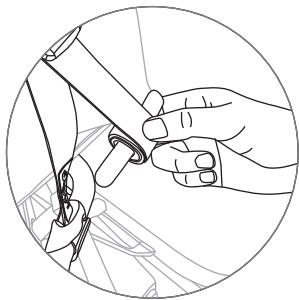

3. 绑紧后, 调整织带收纳带长度并粘合魔术贴。

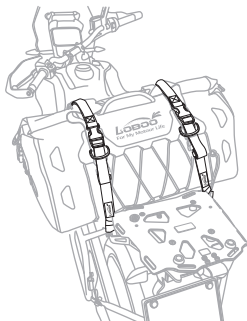

4. 操作完成。

## 使用注意事项

1. 每次使用完毕后用柔软的湿毛巾和肥皂(请勿使用漂白剂、柔顺剂或其他酸碱性清洁剂)擦拭去除防水包表面污渍,不可机洗、熨烫、干洗以及任何形式的烘干,让其自然风干,请勿置于阳光下长时间暴晒。
2. 长时间不使用时,防水包应放置在干燥、阴凉的环境中,避免发霉对防水包造成损坏;并定期清洁防水包表面的灰尘和污垢,延长使用寿命。
3. 出行前检查防水包的提带、肩带和快拆绑带,避免老化影响正常使用。户外恶劣环境使用时,不要在防水包表面使用防虫剂。使用时请避免尖锐物品划伤防水包面料,以免影响防水性能。

# 售后服务保障卡



请仔细阅读本售后服务保障卡，如不能接受，请及时联系经销商退换货，安装并使用即表示接受此售后服务条款。

## 售后服务条款

1. 1年免费保修期，此款产品自售出之日起1年内，在正常情况下出现质量问题可享受免费维修服务。
2. 有限保修：1年保修时间到期后，LOBOO将提供有偿保修服务，费用以实际更换材料费用为准，不另收取人工费用。

## 免费保修服务不包括以下内容

1. 无保修卡或不能提供有效购买凭证。
2. 安装、使用不当、人为或意外损坏、自行拆解、自行改装和维修等。

## 退换货信息

平台ID: \_\_\_\_\_ 订单编号: \_\_\_\_\_

联系人姓名: \_\_\_\_\_ 联系人电话: \_\_\_\_\_

回寄地址: \_\_\_\_\_

## 售后事项

请妥善保管好此卡并与产品一起寄回（复印件有效）



